



efi REGGIANI PRIMA

Flatbed Printer

The fastest flatbed
in the market

PRIMA. Analogical excellence.

REGGIANI reinvests part of its yearly turnover in research and development in every printing technology – flat and rotary screen printing as well as digital printing – to satisfy a worldwide market looking for top-performing machines. Flat-screen printing keeps the charm and the possibilities of serigraphic printing. Thanks to the first flatbed printing machine launched during the 50s REGGIANI has become the leading worldwide supplier.

For more than 60 years REGGIANI has focused on innovation, quality, and customers' exigencies for competitiveness. This long-lasting history allows REGGIANI to bring PRIMA to the market, the flatbed printing machine that satisfies both high-performing exigencies and simple and friendly machine operations.



- Suitable for any kind of fabric: woven, knitted, elastic, and synthetic, from cotton to silk
- Bridge printing units equipped with rubber squeegees
- Weft wise printing movement
- Pneumatically adjustable squeegee pressure
- Easy and simple operation with touch screens and touch pad
- High flexibility
- Blanket movement control in a closed loop
- Highly reliable and efficient electronics
- High-quality printing blanket driven by brushless motors



The PRIMA flatbed printing machine

EXTRALINE printing technology

PRIMA's control and driving system, like all REGGIANI machines, is made up of top-down interfaces connected through a field-bus.

The easiness and reliability of the system allow top-down access to all the main functions by means of one 15" TFT touch screen and two 6" touch screens (one at the entry and one at the exit of the machine) as well as by means of the control panels on each printing unit.

A built-in modem allows connection to REGGIANI's after-sales service. All the printing parameters and the related data are protected and inaccessible to guarantee customer privacy.

The printing pressure applied on the screen is easily and perfectly achieved, even with big repeats.

Thanks to our latest innovations, great printing evenness is achieved with all the repeats and with no need for any additional equipment.

The peculiar features of hand printing are available because of the innovative pressure/speed adjustment system.

Lifting-up speed, lifting height, and delays can be adjusted for each stroke, satisfying the needs of any printing application. Additionally, all of the the printing parameters can be easily saved and reproduced thanks to the top-down interfaces.

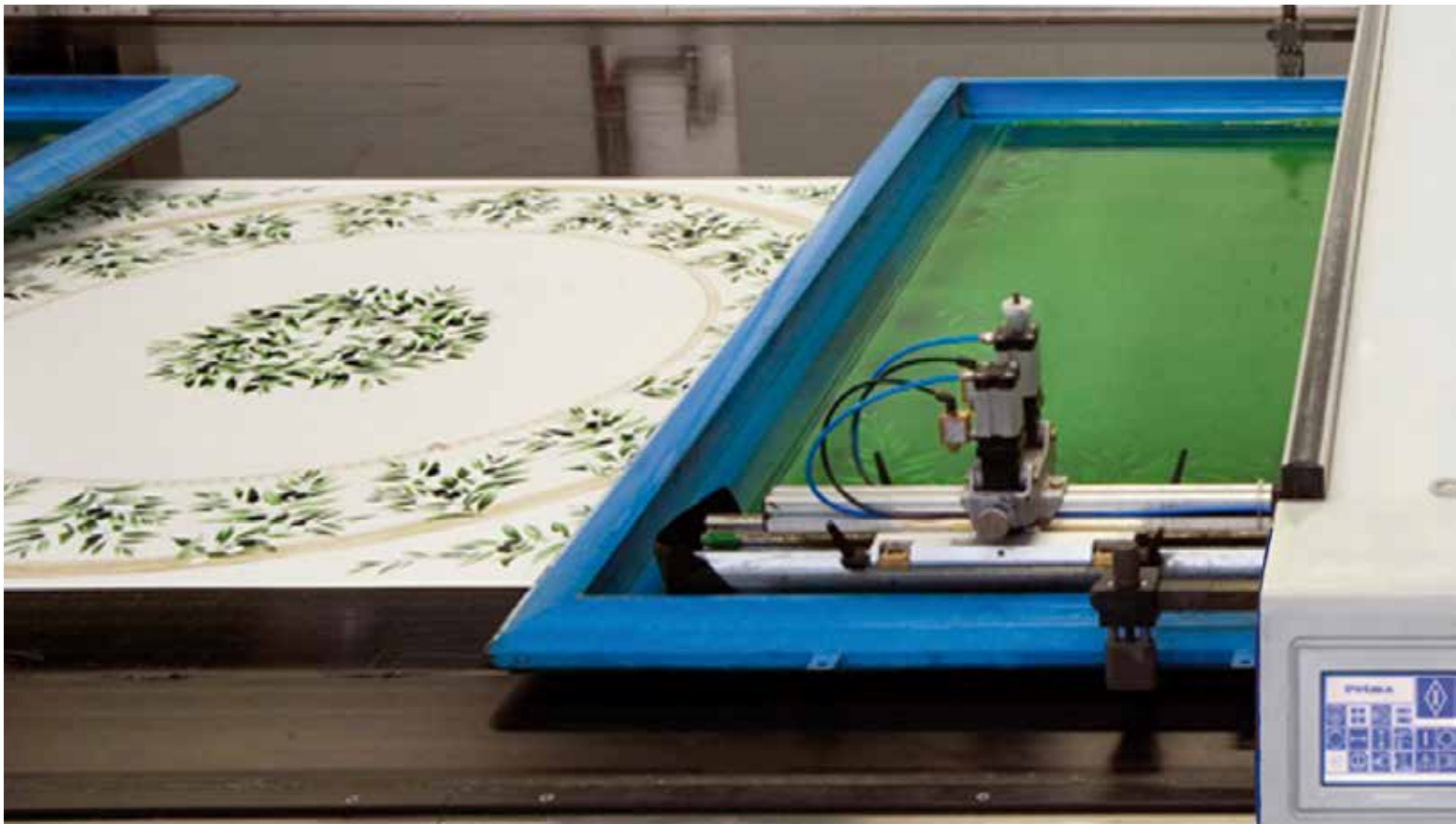

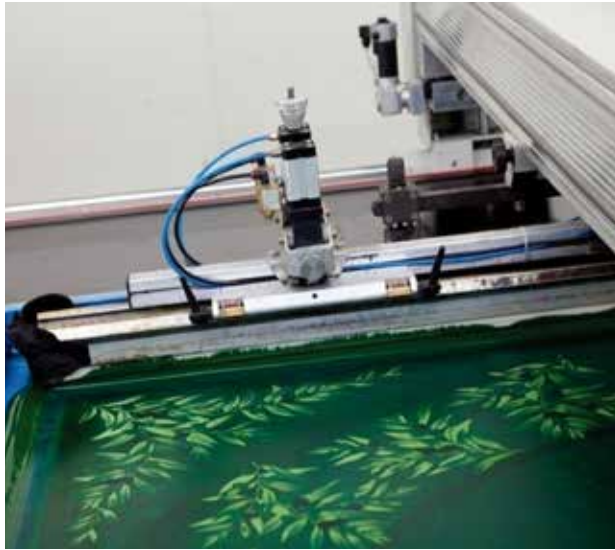

Machine entry/Dynaplast

The fabric feeding uses built-in devices to keep all desired variables constant and controlled, like:

- Fabric width
- Fabric tension
- Kind of fabric

The Dynaplast system synchronizes the discontinuous blanket advancement with the entry speed by providing constant speed at the introduction of fabric. This reduces the fabric tension and is particularly suitable for knitted fabric.

The Dynaplast system can be heated, which allows you to glue the fabric onto the printing blanket in case of thermoplastic adhesives.

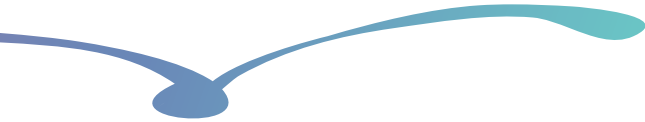
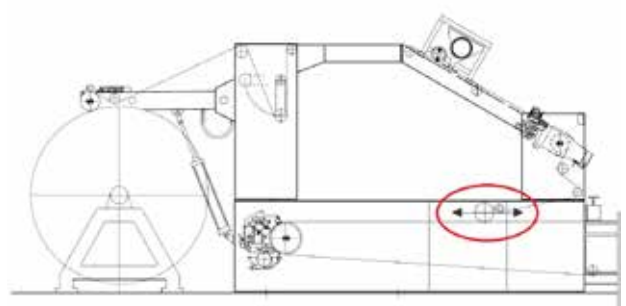
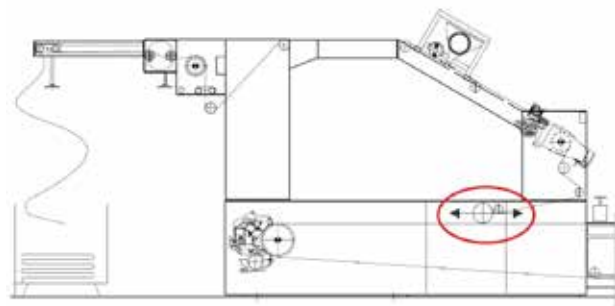



15" main touch screen with colors



Touch screen for adjustment and drive of printing heads

Control panel

The control panel, placed on the operating side of each printing unit, has the following functions:

- Printing speed: from 1 to 9, independently adjustable for each direction
- Printing mode: from 1 to 9, squeegees or flood stroke
- Printing pressure: from 1 to 9, independently adjustable for each direction
- Intermediate delays between the squeegee passages
- Adjustable lifting height to enable printing blanket advancement
- Adjustable and self-learning squeegee stroke
- Test of a printing cycle with the selected parameters (cycle test)
- Unlocking device for printing unit's movement along the printing table

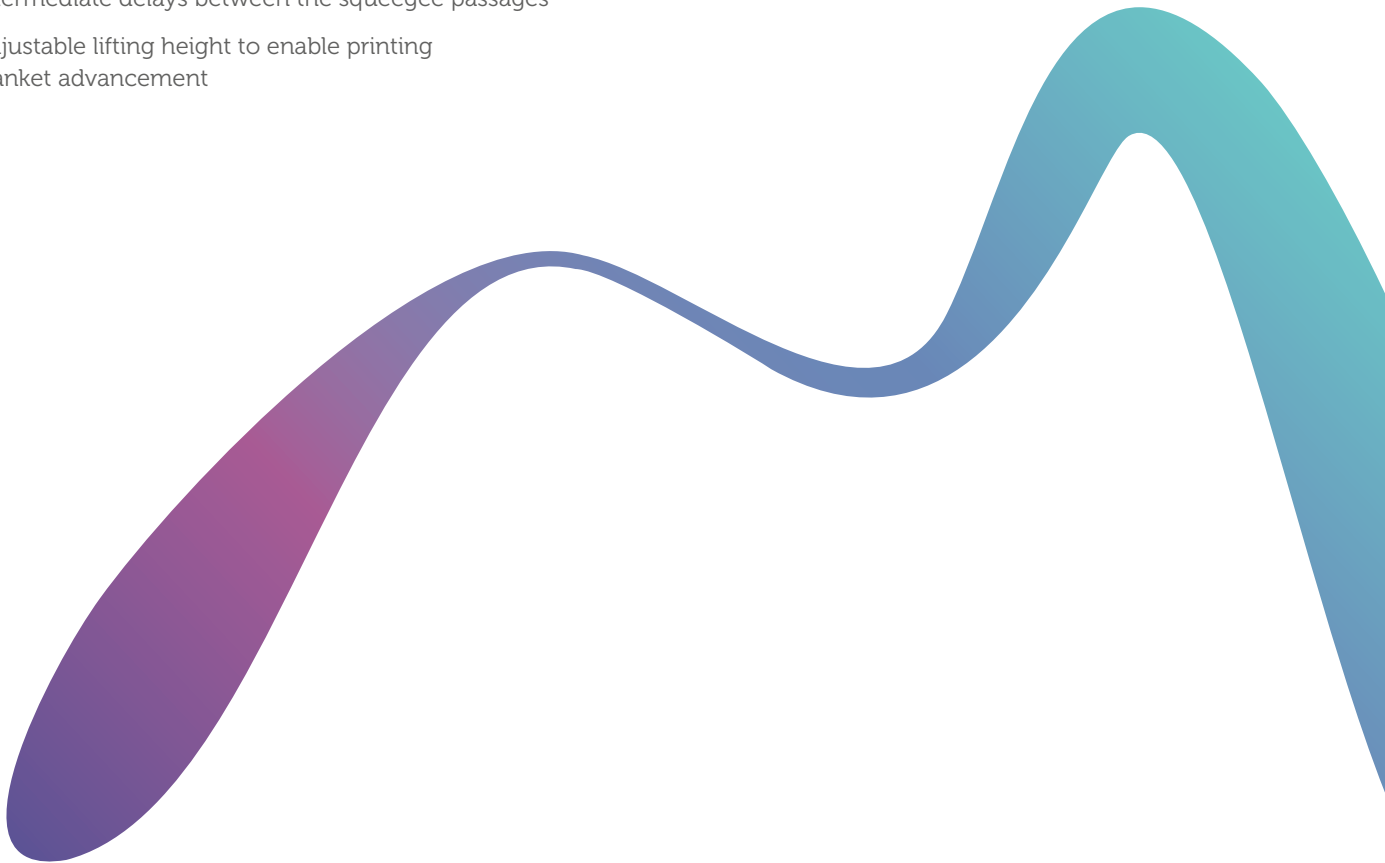

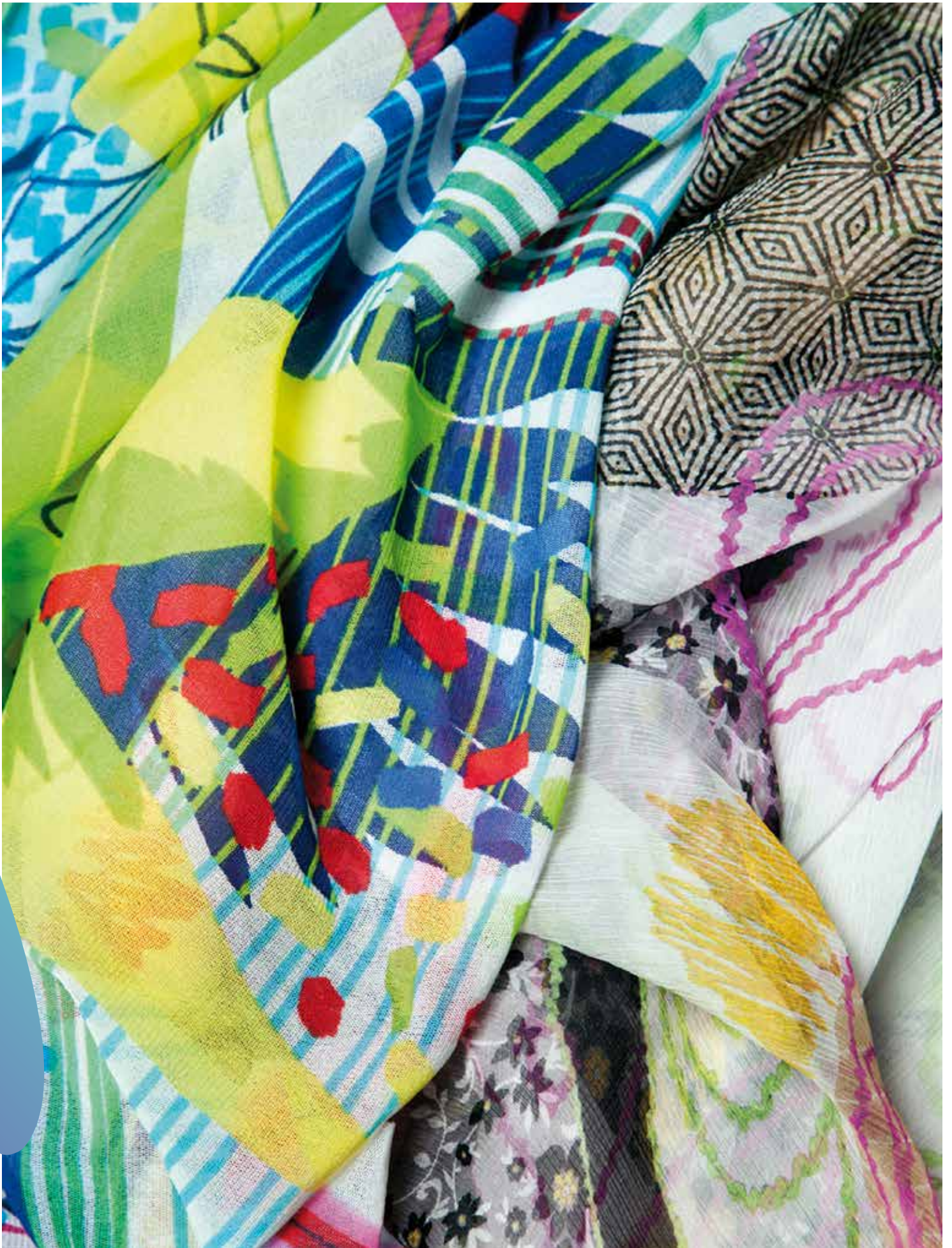

TECHNICAL DATA

Models	71, 125, 134 ft (180, 320, 340 cm)
Useful printing table	32÷183 ft (10÷56 m)
Number of installable colors	from four to max 24
Repeat fractioning	optional
Squeegee pass	weft wise
Squeegee system	bridge, EXTRALINE
Printing unit set up	independent per each printing unit
Advancement	at adjustable speed
Screen lifting up	at individually adjustable height and speed
Flat screens	serigraphic with four hook-up devices
Operating side	right or left (upon request)
Color feeding	manual or automatic (optional)
Printing table height	32 in (80 cm) from the ground

REGGIANI reserves the right to modify, at any moment and without prior notice, the data and technical specifications published herein.

Options

MSP (Multi Stepping Printing): 'Jumping' printing for 'Sarees'.

EFI fuels success.

We develop breakthrough technologies for the manufacturing of signage, packaging, textiles, ceramic tiles, and personalized documents, with a wide range of printers, inks, digital front ends, and a comprehensive business and production workflow suite that transforms and streamlines the entire production process, increasing your competitiveness and boosting productivity. Visit www.efi.com or call 650-357-3500 for more information.



Nothing herein should be construed as a warranty in addition to the express warranty statement provided with EFI products and services.

The APPS logo, AutoCal, Auto-Count, Balance, BESTColor, BioVu, BioWare, ColorPASS, Colorproof, ColorWise, Command WorkStation, CopyNet, Cretachrom, Cretaprint, the Cretaprint logo, Cretaprinter, Cretaroller, Digital StoreFront, DirectSmile, DocBuilder, DocBuilder Pro, DockNet, DocStream, DSFdesign Studio, Dynamic Wedge, EDOX, EFI, the EFI logo, Electronics For Imaging, Entrac, EPCount, EPPPhoto, EPRegister, EPStatus, Estimate, ExpressPay, FabriVU, Fast-4, Fiery, the Fiery logo, Fiery Driven, the Fiery Driven logo, Fiery JobFlow, Fiery JobMaster, Fiery Link, Fiery Navigator, Fiery Prints, the Fiery Prints logo, Fiery Spark, FreeForm, Hagen, Inkintensity, Inkware, Jetrion, the Jetrion logo, LapNet, Logic, Metrix, MicroPress, MiniNet, Monarch, OneFlow, Pace, Pecas, Pecas Vision, PhotoXposure, PressVu, Printcafe, PrinterSite, PrintFlow, PrintMe, the PrintMe logo, PrintSmith, PrintSmith Site, PrintStream, Print to Win, Prograph, PSI, PSI Flexo, Radius, Remoteproof, RIPChips, RIP-While-Print, Screenproof, SendMe, Sincolor, Splash, Spot-On, TrackNet, UltraPress, UltraTex, UltraVu, UV Series 50, VisualCal, VUTEK, the VUTEK logo, and WebTools are trademarks of Electronics For Imaging, Inc. and/or its wholly owned subsidiaries in the U.S. and/or certain other countries.

All other terms and product names may be trademarks or registered trademarks of their respective owners, and are hereby acknowledged.